

Welcome to the DVISION family. We hope you will enjoy your ride with your new head-up display. To get you started straight away, we will present all important information regarding the installation and operation of DVISION on the next few pages.

DVISION – explained simply

DVISION gives you the freedom to decide what is important to you during your motorbike ride. The customisable head-up display has been developed for your freedom and safety. You no longer need to look down to check your speed, navigation system or compass during your ride. The information is displayed directly in front of your eyes, so you always have everything in sight.

With DVISION you always keep your ride in sight. Against distractions, for your independence. Stay focused, free and enjoy your ride!

Manufacturer's contact details

TILSBERK c/o digades GmbH

Äußere Weberstraße 20

02763 Zittau

Germany

service@tilsberk.com

Content

1	Product overview	4
1.1	Scope of delivery.....	4
1.2	Components of the DVISION module and helmet adapter.....	5
1.3	DVISION app	6
1.4	Display icons.....	6
1.5	Meaning of the LED display on the DVISION module.....	9
2	Safety	10
2.1	Important warnings and safety information.....	10
2.2	Limits of the system	12
2.3	Storage and wintering.....	12
2.4	Notes on cleaning and maintenance	13
2.5	Notes on disposal	14
3	In-helmet installation.....	15
3.1	Installation instructions.....	15
3.2	Examples of helmet types.....	17
3.3	Mounting variant A: clamping in the helmet adapter with tabs	20
3.4	Mounting variant B: gluing in the helmet adapter with tabs.....	22
3.5	Mounting variant C: using an adhesive pad to glue in the narrow helmet adapter	25
3.6	Mounting variant D: using Sugru to glue in the narrow helmet adapter	28
4	Operation.....	34
4.1	Installing and setting up the DVISION app.....	34
4.2	Setting up and using the DVISION module.....	37
4.3	Starting the navigation	38
4.4	Settings.....	42
5	Troubleshooting	47
5.1	Reconnecting the DVISION module after pairing has failed	47
5.2	Replacing the display.....	47
6	Technical data.....	49

1 Product overview

1.1 Scope of delivery

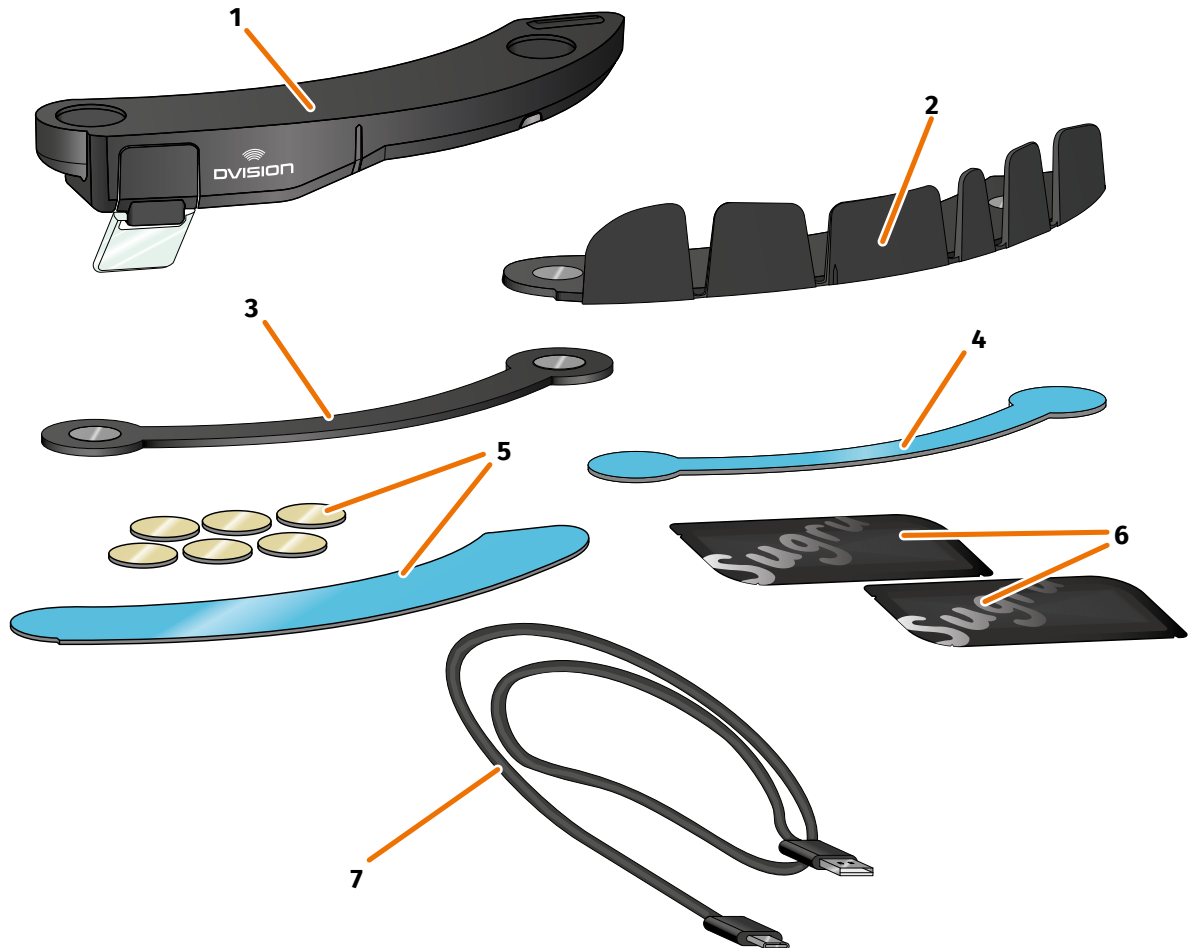

FIGURE 1 // Scope of delivery

- | | | | |
|----------|--|----------|--|
| 1 | DVISION module | 2 | DVISION helmet adapter with tabs |
| 3 | DVISION helmet adapter narrow | 4 | Adhesive pad for DVISION helmet adapter narrow |
| 5 | Adhesive pads for DVISION helmet adapter with tabs | 6 | Two packs of Sugru (mouldable multipurpose glue) |
| 7 | USB-C charging cable | 8 | DVISION protective cover (not pictured) |
| 9 | DVISION Quick Start Guide (not pictured) | | |



INFO

Before using your device, check that no parts are missing and there is no external damage.

1.2 Components of the DVISION module and helmet adapter

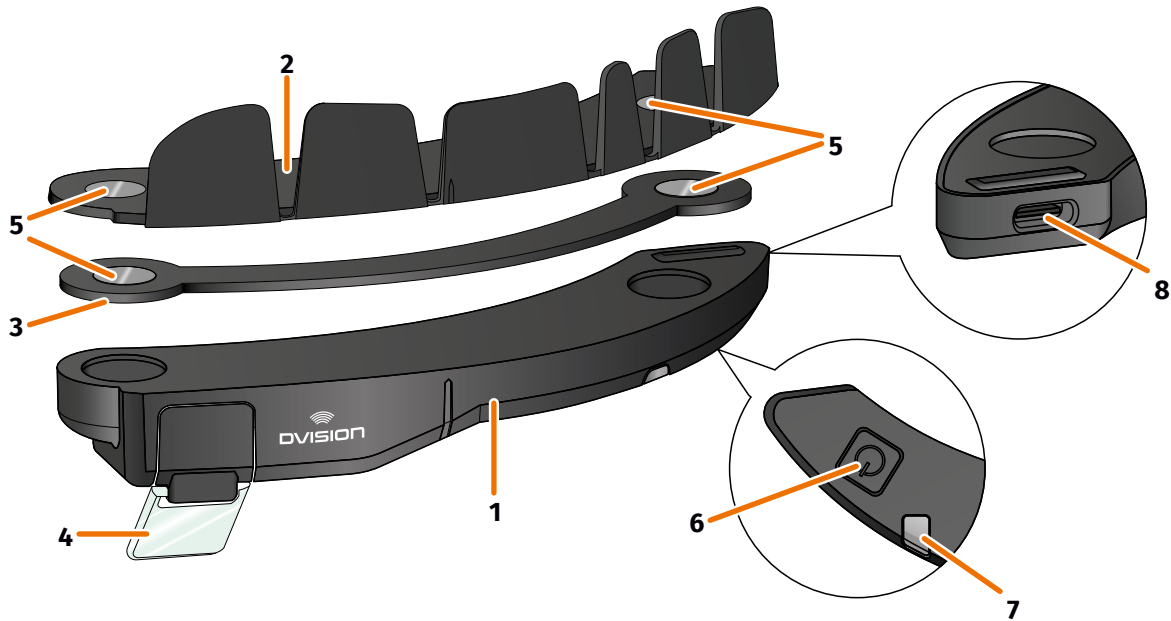

FIGURE 2 // Overview of the DVISION module and helmet adapter with tabs

- 1 DVISION module
- 2 Helmet adapter with tabs
- 3 Narrow helmet adapter
- 4 Display
- 5 Magnetic holder for the DVISION module
- 6 Operating button
- 7 Status LED with integrated light sensor
- 8 USB-C charging socket

DVISION consists of two main components: the helmet adapter that is installed in your motorbike helmet and the DVISION module that is affixed to the helmet adapter via a magnetic connection.

The narrow outer side of the DVISION module features a USB-C charging socket that is used to charge the DVISION module.

The bottom of the DVISION module features a transparent, adjustable display, a status LED with integrated light sensor and operating button for the DVISION module. The operating button is used to switch the module on and off.

To enable installation in as many types of helmet as possible, DVISION comes with two different helmet adapters that can be installed in different types of helmet.

1.3 DVISION app

The DVISION app is the interface between you and the DVISION module. It supplies the DVISION module with the data that will guide you to your destination during your ride. To do so, the DVISION app uses online maps and the location service of your smartphone.

The data is sent to the DVISION module via a Bluetooth connection and shown on the display. The DVISION app also sends phone data to the DVISION module so that the battery level of your smartphone and incoming calls are also displayed.

Once you have set up the DVISION app for the first time, you can use the settings to configure the displays, favourite destinations and route setting.

1.4 Display icons

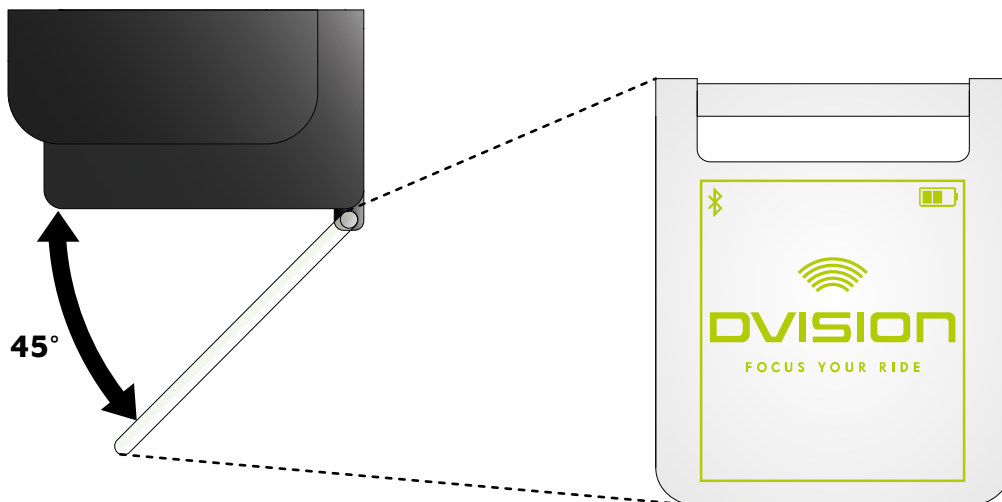

FIGURE 3 // Display (example)

Depending on the settings in the DVISION app, the display will show the following information and notes:



Bluetooth status

The display shows if you are connected to your smartphone via Bluetooth.

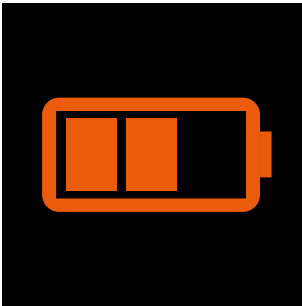

DVISION battery level

The display lets you keep an eye on the battery level of your DVISION module. Each of the three bars in the battery symbol represents 25% of the maximum battery charge.

If all three bars have disappeared, 25% of battery charge remain. In addition, a warning appears on the display.



Smartphone battery warning

The display warns you when the battery level of your smartphone is low.

The exact battery level at which the warning appears depends on your smartphone.

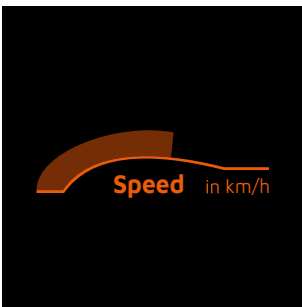

Current speed

The speed indicator shows you your current speed. The bar above the line signals your speed change if you accelerate or brake.



Speed limit

The display shows the permissible maximum speed stored in the map service for your current position and riding direction. If you exceeded the current speed limit, the frame of the display is brighter.

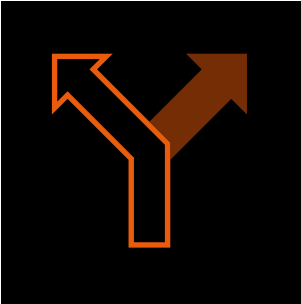

Turning directions

The arrows on the display guide you along the calculated route and show when you have to turn and in which direction.

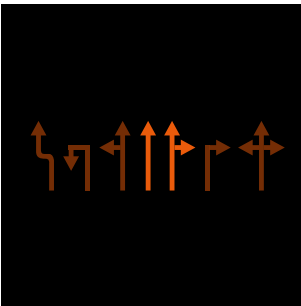

Lane information

The lane information provides information on the lanes available and turn-offs from the road.



Compass

The compass shows you in which cardinal direction you are currently travelling. The cardinal direction is determined using your moving location signal.



Phone notifications

The display shows your incoming calls. If the number is stored in your contacts, the display will also show the corresponding name.

Navigation time

The display shows your navigation time. You can choose between the estimated time of arrival and the estimated remaining time to the destination.

Distance to destination

The display shows you the remaining distance to your destination.

Location

The display shows your location. You can choose between displaying the current road and the next road on your route.

Time

The display shows the current time.

You can use the settings in the DVISION app to select from different display layouts and hide some icons (“Configuring the display layout” on page 41).

1.5 Meaning of the LED display on the DVISION module

The status LED on the DVISION module indicates the current status of the device:

The LED flashes once	The DVISION module is being activated.
The LED flashes twice	The DVISION module is being deactivated.
The LED flashes three times and the device switches off	The DVISION module is turned off automatically due to the battery level.
The LED lights up continuously	The DVISION module is being charged.
The LED is switched off, the DVISION module is connected to charge	The DVISION module is fully charged.
The LED flashes approx. twice per second, the DVISION module is connected to charge	Charging error.

2 Safety

2.1 Important warnings and safety information



WARNING!

This version of DVISION is designed for riding in right-hand traffic. The display is located in front of the right eye outside of your main field of vision. When used in left-hand traffic, the display may be in your main field of vision and possibly obstruct your view of the road. Follow these instructions when using DVISION in left-hand traffic.



WARNING!

DVISION includes small parts that can be dangerous to children. Especially if small parts are swallowed, there is an acute risk of choking! Always keep your DVISION out of reach of children.



WARNING!

DVISION may malfunction if it has been exposed to high humidity or hot temperatures (above 50°C). Malfunctions can be irritating while riding and lead to accidents. Keep DVISION away from liquids and high temperatures. However, brief contact with water splashes or use in fog are harmless.



WARNING!

The installed lithium-ion polymer battery cannot be replaced. Doing so could result in the battery leaking, bursting into flames and exploding and thus causing serious injuries. Do not attempt to change the battery.



WARNING!

DVISION is not suitable for persons suffering from epilepsy. The light signals on the display can trigger epileptic seizures.



WARNING!

DVISION is not suitable for persons with a unilateral, uncorrected visual impairment. The display may further obstruct a limited field of vision and thus prevent you from being able to see traffic sufficiently.



WARNING!

Inattentiveness in traffic can lead to accidents and serious injuries. The use of DVISION does not release you from your responsibility to ride carefully and according to the rules. Select the route and all settings before you start your ride. Road rules and signs on the road always take precedence over what appears on the display.



NOTE!

DVISION contains sensitive components. Incorrect storage, contact with liquids (fully or partially submerged) and shocks due to falls or impacts can damage the device and impair its function. Store your DVISION in the protective cover provided. Keep your DVISION away from liquids.



NOTE!

If your DVISION gets hot during the ride or if you notice smoke or deformation of the device, keep calm and pull over on the side of the road as soon as you can. Take off your helmet and remove the DVISION module from the helmet. Do not keep using the device under any circumstances. Contact the manufacturer and have the device checked, repaired or replaced ("Manufacturer's contact details" on page 1).



NOTE!

The device must not be used in ECE 22.06 certified helmets!

2.2 Limits of the system

DVISION will always try to take you to your destination. Despite all care and technical precision, however, it is not possible to guarantee this function in all situations:

- // Unstable or unavailable internet connection: if your smartphone is unable to establish a connection to the internet, it might not be possible to record all route data.
- // Unstable or unavailable location services: the DVISION app detects your position by using your smartphone's location services. If your location services are switched off or your location data is not available, the DVISION app cannot detect your position and speed. This can happen, for example, in tunnels or dense forests, between high buildings or in the mountains.
- // Offroad: the DVISION app calculates the route using existing map material and guides you along roads and paths. If you are not near a road, the DVISION app cannot calculate a route to your destination. However, you can still use the compass.
- // Missing or outdated map material: the DVISION app guides you to your destination using existing map material. In some cases, map material might be out of date, which can result in the route guidance not working correctly. This can happen in the following cases:
 - // If new roads have been built and have not yet been recorded
 - // If traffic routing changes due to new road rules
 - // If the map material is not available for certain regions
- // Particular riding situations: DVISION is not suitable for use in races, competitions or enduro, motocross and supermoto events.

2.3 Storage and wintering

If you want to store your DVISION while you are not using it, pay attention to the ambient conditions at the storage location and the condition of your device:

- // Temperature: between 0 °C and +50 °C
- // Protected from light: use the protective cover provided and store the device away from direct sunlight.
- // Dry: away from sources of water and other liquids
- // Charged: charge the battery before you store the device for an extended period of time.

INFO



You can also leave your DVISION mounted in the helmet. Make sure that the device is also protected from humidity, extreme temperatures and direct sunlight in this case.

2.4 Notes on cleaning and maintenance

Avoid dirt

Try to avoid stubborn dirt. In particular oil and fuel, but also sticky liquids damage the device. Observe the following notes:

- // If possible, store and transport your DVISION in the protective cover provided or leave it mounted in the helmet.
- // Make sure your hands are free from oil and fuel residues when you touch the display and optical output area.

Cleaning the DVISION module

You can't always avoid dirt. Humidity, dust and particles in the air settle on the surface of the device. If you want to clean your device, proceed as follows:



NOTE!

Do not use pressurised air or chemical detergents to clean the DVISION module. Pressurised air and chemicals can damage the surfaces of the display and the optical output area as well as their function.

1. Remove the DVISION module from the helmet.
 2. Use the protective cover provided or a clean microfibre glass cleaning cloth to thoroughly clean the DVISION module. In particular, make sure that there is no dirt on the light sensor or the display.
 3. To remove stubborn dirt, lightly moisten the protective cover or glass cleaning cloth with clear water. Do not use chemical detergents.
 4. If you are unable to remove dirt, contact the manufacturer and discuss what to do next ("Manufacturer's contact details" on page 1).
- ▶ Once the light sensor and display are free from dirt and function correctly, the cleaning of the DVISION module is complete.

Cleaning a helmet with an installed helmet adapter

To clean your helmet, remove the DVISION module from the helmet. You can clean the outside of your helmet as you normally would when the helmet adapter is installed. Follow the helmet manufacturer's instructions when doing so.

If the helmet adapter is affixed to the fabric of the lining, do not wash the lining in the washing machine.

Cleaning a helmet after removing the helmet adapter

The helmet adapter can be easily removed from the helmet with a bit of force. The adhesive pads and especially Sugru can leave residue in the helmet.

On hard surfaces, the residues can easily be removed with a moist cloth. If you want to use detergents or solutions containing alcohol, follow the helmet manufacturer's instructions.

Slight glue residues might remain permanently on fabric.



INFO

If you remove the helmet adapter from the helmet, you cannot reuse the glue.
 If you want to re-install the helmet adapter in the helmet, remove glue residues from the helmet adapter first. You can use an alcohol wipe to do so.
 Then reinstall the helmet adapter in the helmet.

Maintenance

You can change the display of your DVISION module yourself, if the display is damaged or has become dull (Chapter 5.2 on page 46).

If you want to have your DVISION serviced or checked, contact the manufacturer (“Manufacturer’s contact details” on page 1).

Serial number

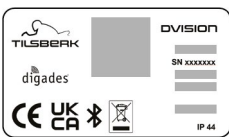

If you want to contact the manufacturer to have your DVISION serviced or checked, keep the serial number of your device at hand. You will find the serial number on the label on the top of the DVISION module as well as in the “Settings” menu in the DVISION app once the device has been paired.

2.5 Notes on disposal

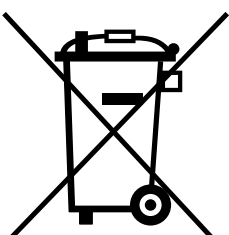

Dispose of the product in accordance with local rules and regulations.

The device with the built-in battery may only be disposed of properly via collection boxes in shops or at municipal collection points.

Do not dispose of the device and the battery it contains with household waste.

3 In-helmet installation

3.1 Installation instructions

Before your DVISION can guide you to your destination, you have to install it in your helmet. The following section helps you prepare for installation and choose the right mounting type for your helmet.

Mounting surface

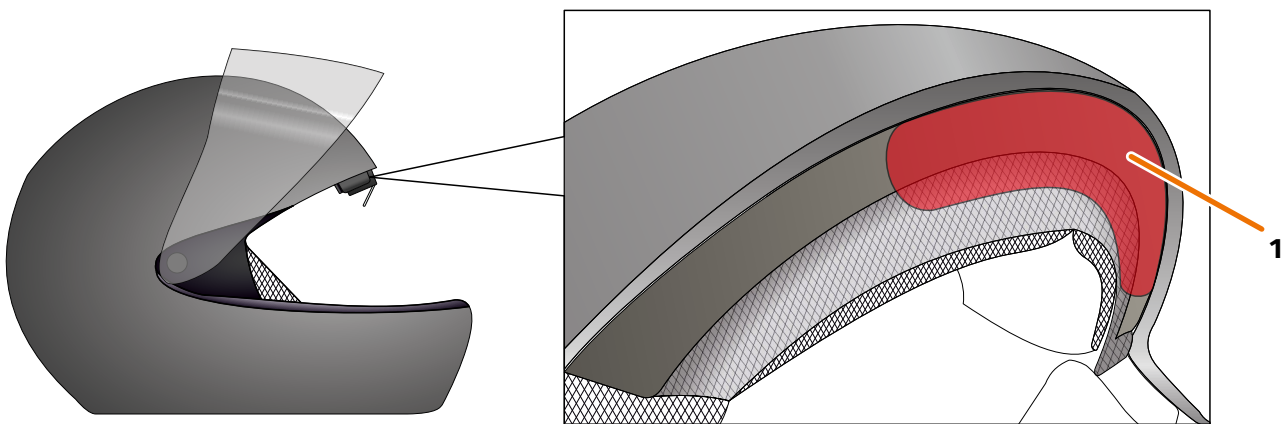

FIGURE 4 // Mounting surface (example)

The helmet adapter is mounted on the flat surface in the forehead area of the helmet (FIGURE 4/1). Following that, the magnets are used to affix the DVISION module to the helmet adapter.

Preparing the installation

There are several options for attaching the helmet adapter to the helmet. The right option for your helmet depends on the shape of the helmet and the materials used in the helmet. The right type of attachment for your helmet should ensure the best possible hold strength and should affect the functionality of the helmet as little as possible.

To correctly prepare the installation, proceed as follows:

1. Determine your helmet type and the appropriate mounting variant (FIGURE 5).

INFO



The pages after the decision guide (FIGURE 5) provide examples of different helmet types and material types as well as details on how to select a mounting variant (Chapter “3.2 Examples of helmet types”, p. 16).

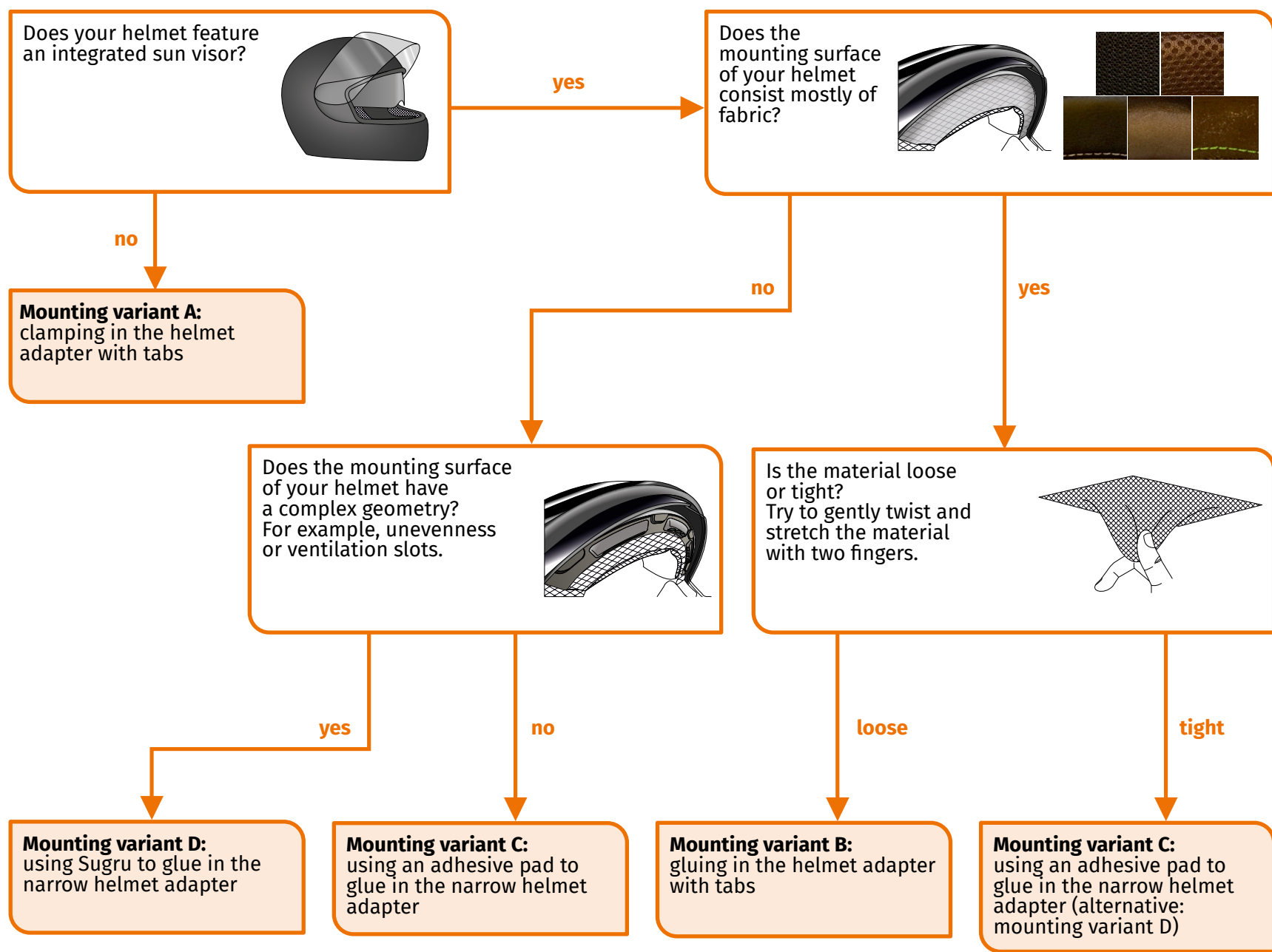

FIGURE 5 // Decision guide: selecting the helmet adapter

INFO



If none of the mounting variants match your helmet type, please contact the manufacturer to discuss alternatives (“Manufacturer’s contact details” on page 1).

- “Mounting variant A: clamping in the helmet adapter with tabs” on page 19
 - “Mounting variant B: gluing in the helmet adapter with tabs” on page 21
 - “Mounting variant C: using an adhesive pad to glue in the narrow helmet adapter” on page 24
 - “Mounting variant D: using Sugru to glue in the narrow helmet adapter” on page 27
2. Place all materials from the delivery scope that are required for your mounting type on a clean, level and well lit surface.
 3. Thoroughly clean the mounting surface of your helmet. Follow the manufacturer’s instructions for doing so.
- ▶ Installation preparation is complete.

3.2 Examples of helmet types

Helmets without sun visor

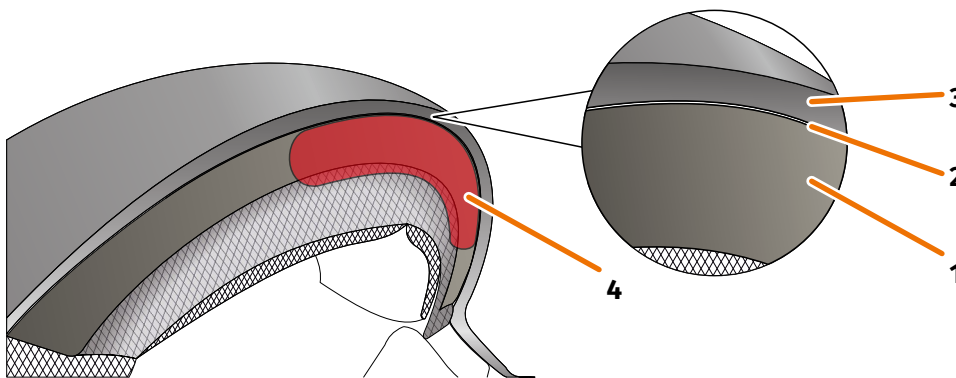

FIGURE 6 // Gap in helmets without sun visors

- 1 Inner shell
- 2 Gap between inner shell and outer shell
- 3 Outer shell
- 4 Position of the helmet adapter with tabs (example)

Helmets without sun visors have a gap (FIGURE 6/2) between the outer shell (FIGURE 6/3) and the inner shell (FIGURE 6/1), into which you can clamp the helmet adapter with tabs.

1. Use a flat object, e.g. a plastic card or ice cream stick to check if the gap has sufficient space for the tabs of the helmet adapter.

INFO



For some helmets, you first have to open up the gap a little bit. The gap should be easy to open by pulling the outer shell of the helmet with your hands.

2. If there is sufficient space in the gap and the object is wedged in the gap, proceed with mounting variant A (Chapter 3.3 on page 19).
3. If the gap is too small or cannot be opened at all, proceed as though your helmet had a sun visor (“Decision guide: selecting the helmet adapter” on page 15).

Material types

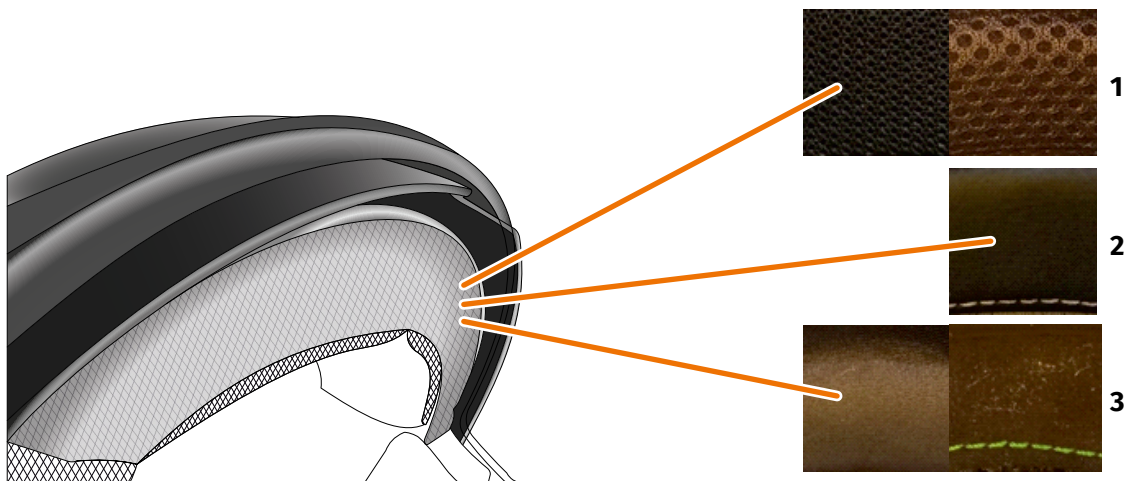

FIGURE 7 // Examples of materials for helmets with material on the mounting surface

- 1 Course mesh material
- 2 Leather or artificial leather
- 3 Fine mesh material (for example, viscose or microfibre)

If the material of the helmet padding extends to the mounting surface, check the type and flexibility of the material.

1. Try to gently twist and stretch the material with two fingers.
2. If the material is smooth and hard to grip and stretch, the mounting surface of your helmet is tight. Continue with mounting variant C (Chapter 3.5 on page 24).
3. If the material can be stretched, check if the helmet adapter with tabs fits into the gap for the sun visor without colliding with the sun visor.

INFO



If the tabs of the helmet adapter collide with the sun visor, this helmet is not suitable for installing DVISION. In this case, please contact the manufacturer to discuss alternatives (“Manufacturer’s contact details” on page 1).

4. If the helmet adapter with tabs fits into the gap for the sun visor without colliding with the sun visor, continue with mounting variant B (Chapter 3.4 on page 21).

Complex helmet geometries

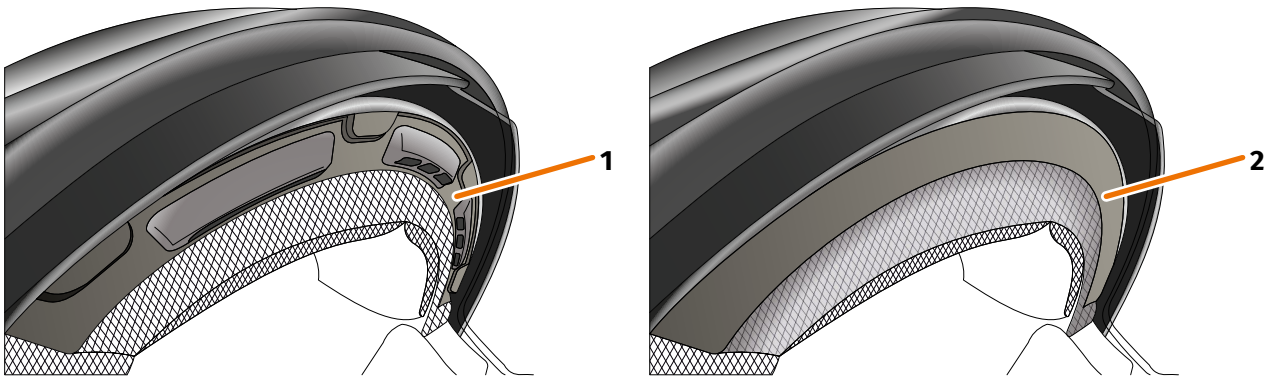

FIGURE 8 // Examples of complex helmet geometries

- 1 Example of ventilation slots
- 2 Example of layer between material and plastic frame

When it comes to complex helmet geometries, distinguish between helmets with ventilation slots and helmets with a layer between the padding material and the plastic frame. In some cases, there is also material with quilted seams that make the mounting surface uneven. Curved mounting surfaces also prevent the helmet adapter from lying flat against the helmet.

- ▶ If the mounting surface of your helmet features a complex geometry, proceed with mounting variant D (Chapter 3.6 on page 27).

3.3 Mounting variant A: clamping in the helmet adapter with tabs

Video instructions

Detailed video instructions for installing DVISION in helmets without sun visors are available on the internet. To access, scan the QR code or call up the video via the browser link.

dvision-hud.com/install/a

Required components

For this mounting type, you need the following components from the scope of delivery:

- // DVISION module
- // DVISION helmet adapter with tabs

Installing the helmet adapter

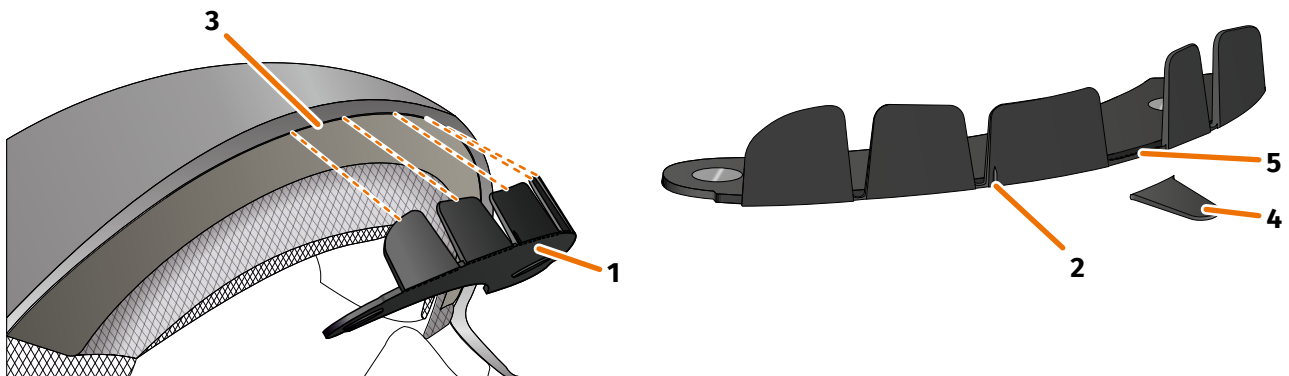

FIGURE 9 // Clamping in the helmet adapter with tabs

1. Place the helmet adapter (FIGURE 9/1) in the forehead section of the helmet. At the front of the helmet adapter, there is a mark (FIGURE 9/2) that should be placed on an imaginary line between the middle of your helmet and the middle of your face.
2. Use both hands to evenly push the tabs into the gap (FIGURE 9/3), until the base plate of the helmet adapter is flush on the mounting surface of the helmet. For some helmets, the gap needs to be pulled open a bit first.



INFO

If you notice that individual tabs collide with the helmet material in the gap in the helmet, you can simply break off up to three tabs (FIGURE 9/4, for example). The helmet adapter is perforated at the lower edge of the tabs (FIGURE 9/5) to facilitate break off. You may use a file or scissors to smoothen the breaking points a little.

Checking the position of the helmet adapter

3. Put your helmet on as usual.
4. Attach the DVISION module to the helmet adapter using the magnets and fold down the display at a 45° angle.
The display should be well visible in front of your right eye.
5. Push the operating button on the DVISION module to switch on the device.
A screen appears on the display.



6. Check if you can clearly see everything on the display in its entirety without changing the position of the helmet on your head. To do so, look ahead as you would if you were riding in traffic:
 - // The display should be well visible in front of your right eye.
 - // The display should be clear and easy to read.
 - // The entire screen should be within your field of vision. Use the frame for orientation when switching on the DVISION module.

INFO



You can show the frame again for alignment orientation at any time. To do so, activate “Alignment mode” in the “Settings” menu.

7. If the display is fuzzy or hard to read, you can change the angle of the display slightly.
 8. If the frame shown on the display is fully or partially outside your field of vision, remove the DVISION module and the helmet adapter from the helmet and slightly move the helmet adapter in the desired direction.
 9. Always recheck the conditions listed in step 6 and keep adjusting the position of the helmet adapter until all conditions are met.
- ▶ You have mounted the helmet adapter with tabs in the helmet. Proceed by setting up the DVISION app (“Installing and setting up the DVISION app” on page 33).

3.4 Mounting variant B: gluing in the helmet adapter with tabs

Video instructions

Detailed video instructions for installing DVISION in helmets using adhesive pads are available on the internet. To access, scan the QR code or call up the video via the browser link.

dvision-hud.com/install/b

Required components

For this mounting type, you need the following components from the scope of delivery:

- // DVISION module
- // DVISION helmet adapter with tabs
- // Set with adhesive pads for DVISION helmet adapter with tabs

Installing the helmet adapter

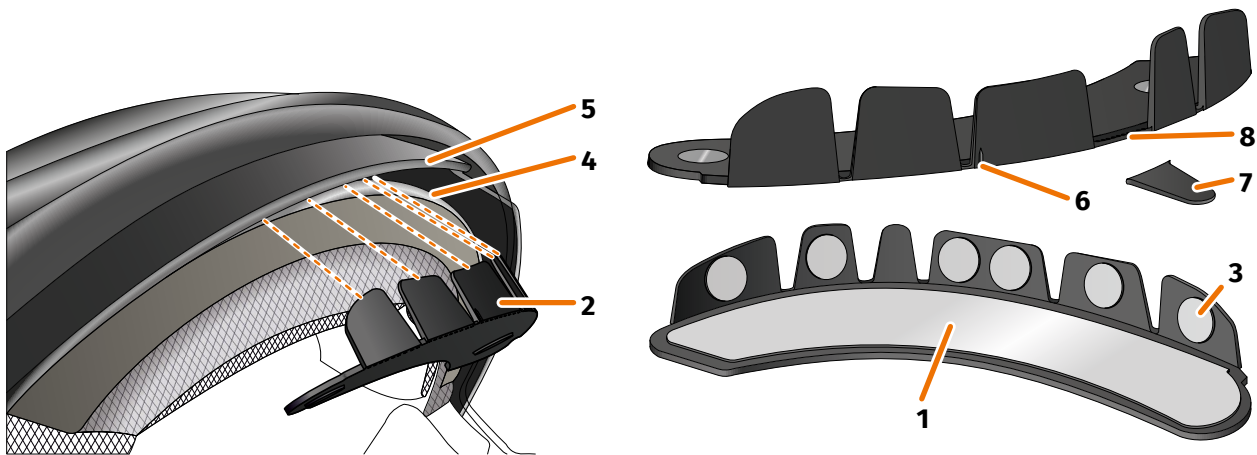

FIGURE 10 // Gluing in the helmet adapter with tabs

1. Apply the large adhesive pad (FIGURE 10/1) to the side of the helmet adapter (FIGURE 10/2) on which you can see the magnets.
2. Apply the small adhesive pads (FIGURE 10/3) to the insides of the tabs.
3. Place the helmet adapter (FIGURE 10/2) in the forehead section of the helmet between the interior shell (FIGURE 10/4) and the sun visor (FIGURE 10/5). At the front of the helmet adapter, there is a mark (FIGURE 10/6) that should be placed on an imaginary line between the middle of your helmet and the middle of your face. Make sure the helmet adapter does not collide with the sun visor.

INFO



If you notice that individual tabs collide with the helmet material, you can simply break off up to three tabs (FIGURE 10/7, for example). The helmet adapter is perforated at the lower edge of the tabs (FIGURE 10/8) to facilitate break off.

4. Evenly push the helmet adapter with the adhesive pads onto the helmet.
5. Check whether the helmet adapter sits correctly on the helmet. To do so, use the magnets to attach the DVISION module to the helmet adapter.
The DVISION module must lie flush against the helmet adapter, without any visible gap between the two.

Checking the position of the helmet adapter

6. Fold down the sun visor to check that the sun visor does not collide with the helmet adapter or the DVISION module.
7. Put your helmet on as usual.
8. Attach the DVISION module to the helmet adapter using the magnets and fold down the display at a 45° angle.
The display should be well visible in front of your right eye.
9. Push the operating button on the DVISION module to switch on the device.
A screen appears on the display.



10. Check if you can clearly see everything on the display in its entirety without changing the position of the helmet on your head. To do so, look ahead as you would if you were riding in traffic:
 - // The display should be well visible in front of your right eye.
 - // The display should be clear and easy to read.
 - // The entire screen should be within your field of vision. Use the frame for orientation when switching on the DVISION module.

INFO



You can show the frame again for alignment orientation at any time. To do so, activate "Alignment mode" in the "Settings" menu.

11. If the display is fuzzy or hard to read, you can change the angle of the display slightly.
12. If the frame shown on the display is fully or partially outside your field of vision, remove the DVISION module and the helmet adapter from the helmet and slightly move the helmet adapter in the desired direction.



INFO

Shortly after mounting, the adhesive pads have not yet developed their full adhesive power. The helmet adapter can be removed easily and then attached again.

13. Always recheck the conditions listed in step 10 and keep adjusting the position of the helmet adapter until all conditions are met.
- ▶ You have used the adhesive pads to attach the helmet adapter with tabs to the helmet. Proceed by setting up the DVISION app (“Installing and setting up the DVISION app” on page 33).

3.5 Mounting variant C: using an adhesive pad to glue in the narrow helmet adapter

Video instructions

Detailed video instructions for installing DVISION in helmets using adhesive pads are available on the internet. To access, scan the QR code or call up the video via the browser link.

dvision-hud.com/install/c

Required components

For this mounting type, you need the following components from the scope of delivery:

- // DVISION module
- // DVISION helmet adapter narrow
- // Adhesive pad for DVISION helmet adapter narrow

Installing the helmet adapter

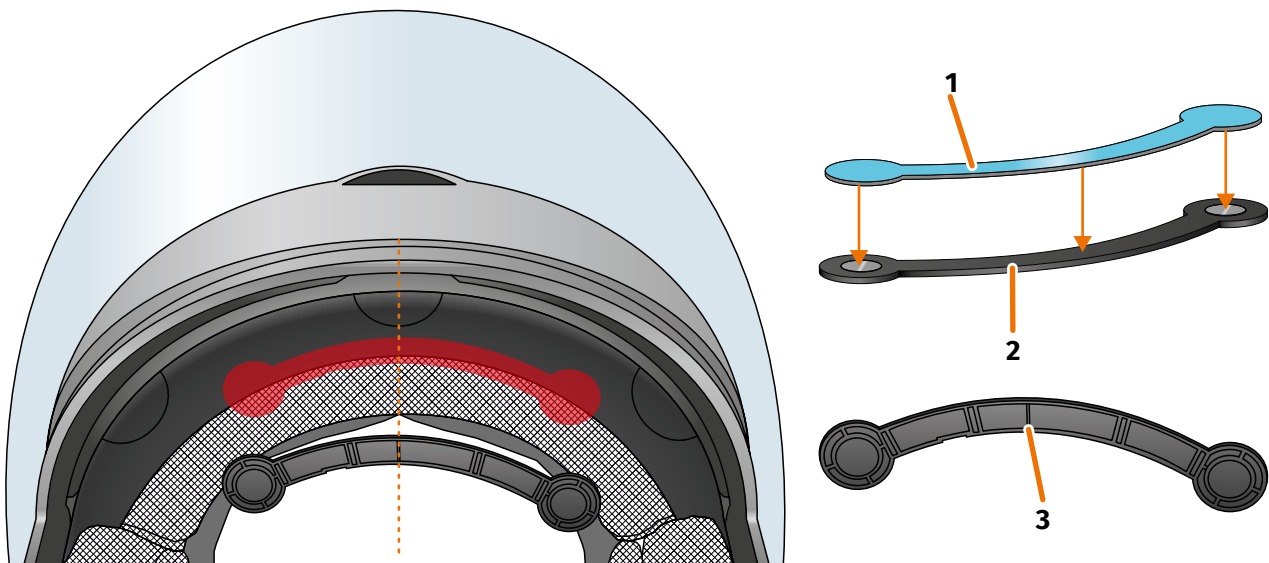

FIGURE 11 // Using an adhesive pad to glue in the narrow helmet adapter

1. Apply the adhesive pad (FIGURE 11/1) to the side of the helmet adapter on which you can see the magnets.
2. Place the helmet adapter (FIGURE 11/2) in the forehead section of the helmet, between the inner shell and the outer shell (FIGURE 11/shown in red). There is a mark at the bottom of the helmet adapter (FIGURE 11/3) that should be placed on an imaginary line between the middle of the helmet and the middle of your face (FIGURE 11/dotted line). Make sure the helmet adapter does not collide with the sun visor.

- Lightly and evenly push the helmet adapter with the adhesive pad onto the helmet.

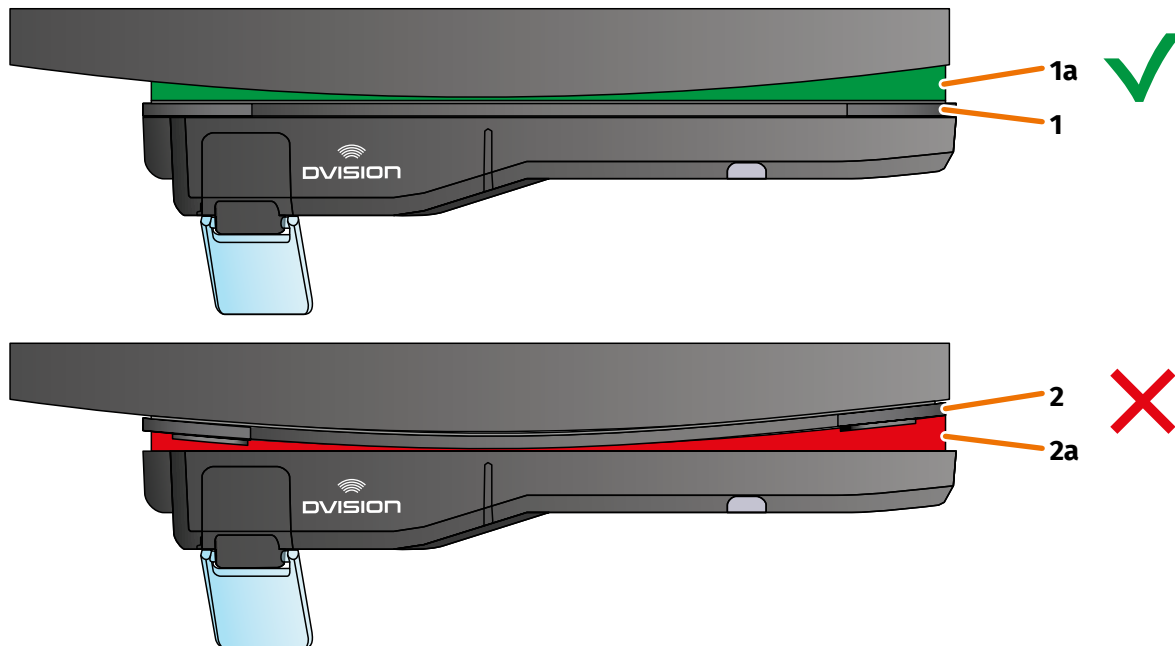

FIGURE 12 // Example: straight and curved mounting surface

- Check whether the helmet adapter sits correctly on the helmet. To do so, use the magnets to attach the DVISION module to the helmet adapter. The DVISION module must lie flush against the helmet adapter (FIGURE 12/1). There must be no visible gap between the DVISION module and the helmet adapter (FIGURE 12/2a). A slight curvature in the mounting surface can be compensated by the adhesive pad (FIGURE 12/1a).

INFO



If the mounting surface is curved and the helmet adapter does not sit correctly against the mounting surface, choose the mounting variant using Sugru (Chapter 3.6 on page 27).

Checking the position of the helmet adapter

- Fold down the sun visor to check that the sun visor does not collide with the helmet adapter or the DVISION module.
- Put your helmet on as usual.
- Attach the DVISION module to the helmet adapter using the magnets and fold down the display at a 45° angle. The display should be well visible in front of your right eye.
- Push the operating button on the DVISION module to switch on the device. A screen appears on the display.



9. Check if you can clearly see everything on the display in its entirety without changing the position of the helmet on your head. To do so, look ahead as you would if you were riding in traffic:

- // The display should be well visible in front of your right eye.
- // The display should be clear and easy to read.
- // The entire screen should be within your field of vision. Use the frame for orientation when switching on the DVISION module.

INFO



You can show the frame again for alignment orientation at any time. To do so, activate “Alignment mode” in the “Settings” menu.

10. If the display is fuzzy or hard to read, you can change the angle of the display slightly.
11. If the frame shown on the display is fully or partially outside your field of vision, remove the DVISION module and the helmet adapter from the helmet and slightly move the helmet adapter in the desired direction.

INFO



Shortly after mounting, the adhesive pad has not yet developed its full adhesive power. The helmet adapter can be removed easily and then attached again.

12. Always recheck the conditions listed in step 9 and keep adjusting the position of the helmet adapter until all conditions are met.
- ▶ You have used the adhesive pad to attach the narrow helmet adapter to the helmet. Proceed by setting up the DVISION app (“Installing and setting up the DVISION app” on page 33).

3.6 Mounting variant D: using Sugru to glue in the narrow helmet adapter



NOTE!

Sugru can leave residues on fabrics and leather. These residues can be hard to remove and traces are likely to remain.



NOTE!

Sugru can partially clog up ventilation slots. If that happens, the helmet is no longer ventilated properly.

Video instructions

Detailed video instructions for installing DVISION in helmets using Sugru are available on the internet. To access, scan the QR code or call up the video via the browser link.

dvision-hud.com/install/d

Required components

For this mounting type, you need the following components from the scope of delivery:

- // DVISION module
- // DVISION helmet adapter narrow
- // Sugru

Preparing Sugru

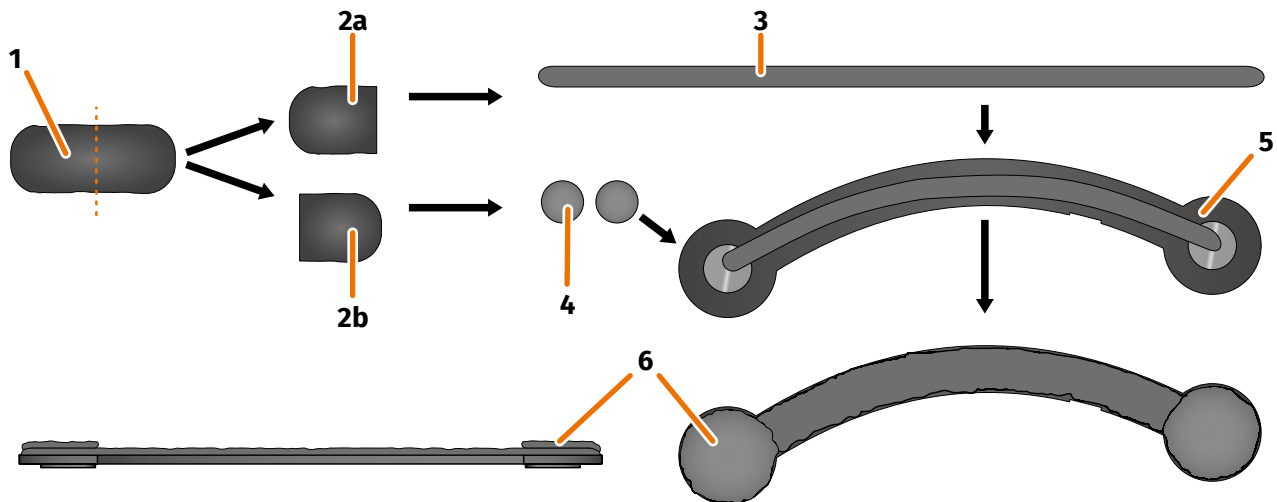

FIGURE 13 // Applying Sugru to the narrow helmet adapter

Sugru hardly needs any preparation to develop adhesive properties. The adhesiveness develops through the reaction of the material with the ambient air.

Once the pack is opened, you have 30 minutes to work with Sugru.

Sugru requires 24 to 48 hours at room temperature to fully set and develop its maximum adhesive force. The exact time required depends on the thickness of the layer as well as the ambient temperature and humidity.

INFO



Sugru is non-irritating to skin. If you experience an allergic reaction after skin contact, rinse the skin with warm water. Follow the manufacturer's instructions.

1. Open a pack of Sugru and remove the content (FIGURE 13/1) from the package.
2. Divide the Sugru into two halves (FIGURE 13/2a and 2b).
3. Use one half of the Sugru (FIGURE 13/2a) to form a roll (FIGURE 13/3) that is approximately as long as the helmet adapter.
4. Split the other half of the Sugru (FIGURE 13/2b) into two equal parts and roll both of them into balls (FIGURE 13/4).
5. Place the roll (FIGURE 13/3) on the side of the helmet adapter on which you can see the magnets (FIGURE 13/5).

6. Use your fingers to carefully and evenly distribute the Sugru over the entire surface of the helmet adapter.
7. Place each of the two balls you have formed on the round ends of the helmet adapter and carefully and evenly flatten them so that they blend with the layer of Sugru that has already been applied (FIGURE 13/6).

Installing the helmet adapter in the helmet

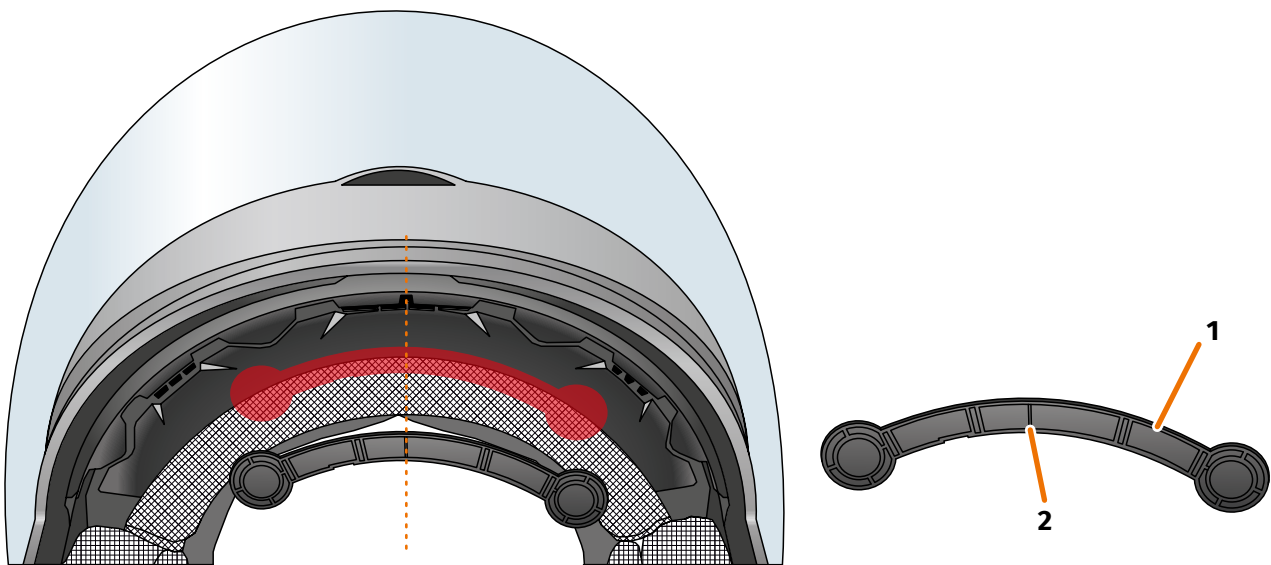

FIGURE 14 // Installing the narrow helmet adapter

8. Place the helmet adapter (FIGURE 14/1) in the forehead section of the helmet, between the inner shell and the outer shell (FIGURE 14/shown in red). There is a mark at the bottom of the helmet adapter (FIGURE 14/2) that should be placed on an imaginary line between the middle of the helmet and the middle of your face (FIGURE 14/dotted line). Make sure the helmet adapter does not collide with the sun visor.

- Carefully and evenly push the helmet adapter onto the mounting surface so that the entire surface of the Sugru adheres to the helmet.

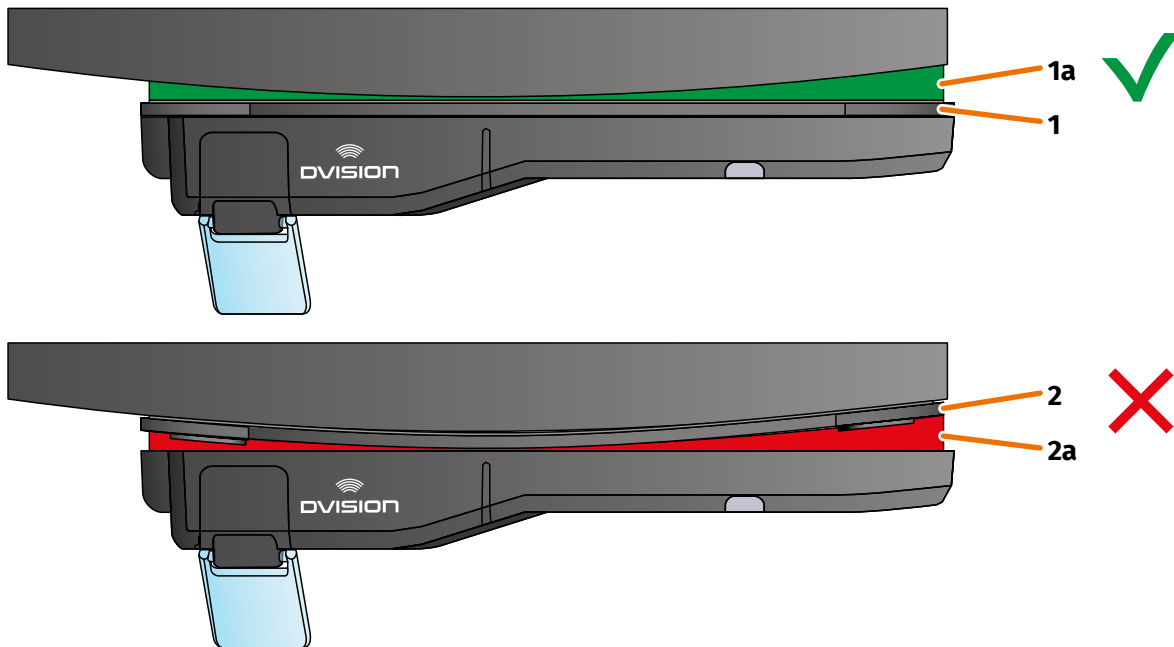

FIGURE 15 // Example: straight and curved mounting surface

- Check whether the helmet adapter sits correctly on the helmet. To do so, use the magnets to attach the DVISION module to the helmet adapter. The DVISION module must lie flush against the helmet adapter (FIGURE 15/1). There must be no visible gap between the DVISION module and the helmet adapter (FIGURE 15/2a). Sugru can compensate a curvature in the mounting surface (FIGURE 15/1a).

INFO



If the mounting surface is curved and the helmet adapter does not sit correctly against the mounting surface, apply an additional layer of Sugru to compensate for the unevenness.

Checking the position of the helmet adapter

- Fold down the sun visor to check that the sun visor does not collide with the helmet adapter or the DVISION module.
- Put your helmet on as usual.
- Attach the DVISION module to the helmet adapter using the magnets and fold down the display at a 45° angle. The display should be well visible in front of your right eye.
- Push the operating button on the DVISION module to switch on the device. A screen appears on the display.



15. Check if you can clearly see everything on the display in its entirety without changing the position of the helmet on your head. To do so, look ahead as you would if you were riding in traffic:

- // The display should be well visible in front of your right eye.
- // The display should be clear and easy to read.
- // The entire screen should be within your field of vision. Use the frame for orientation when switching on the DVISION module.

INFO



You can show the frame again for alignment orientation at any time. To do so, activate “Alignment mode” in the “Settings” menu.

16. If the display is fuzzy or hard to read, you can change the angle of the display slightly.
17. If the frame shown on the display is fully or partially outside your field of vision, remove the DVISION module and the helmet adapter from the helmet and slightly move the helmet adapter in the desired direction.

INFO



Shortly after mounting, the Sugru has not yet developed its full adhesive power. The helmet adapter can be removed easily and then attached again. If the layer of Sugru changes shape when the helmet adapter is removed from the helmet, flatten it with your fingers prior to re-mounting.

18. Always recheck the conditions listed in step 15 and keep adjusting the position of the helmet adapter until all conditions are met.

Reworking Sugru

19. Remove any Sugru that has emerged on the edges of the helmet adapter. Use a flat object to do this, for example, a plastic card or an ice cream stick. Make sure you do not change the position of the helmet adapter.



WARNING!

Until the layer of Sugru has hardened completely, the helmet adapter can come loose during rides due to vibrations and shocks. Let the Sugru harden completely before your first ride.

20. Let the layer of Sugru harden completely before you use the device. Hardening takes 24 to 48 hours at room temperature, depending on the thickness of the Sugru layer. A 1.5 mm layer takes approx. 24 hours while a 3 mm layer takes approx. 48 hours.
 - ▶ You have used Sugru to attach the narrow helmet adapter to the helmet. Proceed by setting up the DVISION app (“Installing and setting up the DVISION app” on page 33).

4 Operation

4.1 Installing and setting up the DVISION app

Installing the DVISION app

Download the DVISION app to your smartphone or tablet from the Google Play Store or from the App Store:

app.dvision-hud.com

Getting started

Once you have successfully installed the DVISION app, you have to set up the DVISION app once.

INFO



To set up the DVISION app and pair it with the DVISION module, charge the DVISION module before you start setting up the DVISION app (Chapter 4.2 on page 36).



When you open the DVISION app for the first time, the start screen appears.

From there, the DVISION app guides you through the setup process up to pairing your DVISION module.

1. Open the DVISION app.
 The start screen is displayed.

2. Tap “NEXT” and following the instructions in the DVISION app.
During setup, you will be asked to grant the following permissions to the DVISION app:
 - // Bluetooth: access to your Bluetooth connection is required to enable the DVISION app to establish the connection to the DVISION module. In this context, you will also be asked to activate Bluetooth on your smartphone if it is not already active.
 - // Location data: access to your current location is necessary to determine your position and current speed.
 - // Phone status: access to your phone status, contacts and call lists makes it possible to show phone notifications on the display. This permission is not strictly necessary for the DVISION app to work. If you do not grant this permission, we cannot show call information on the display.
- ▶ Once you have completed the setup, you are prompted to connect the DVISION module to the DVISION app.

Pairing the DVISION module with the DVISION app



Once you have granted all required permissions to the DVISION app, the DVISION app automatically switches to pairing mode.

3. Ensure that the DVISION module is switched off and sufficiently charged, and near your smartphone.
4. Switch on the DVISION module.
- ▶ After a short time, your DVISION module appears as an available device in the DVISION app.
5. Select the DVISION module to start pairing.
6. Allow Bluetooth pairing on your smartphone. For iOS, this permission does not have to be granted.

INFO



The pairing process can take a few seconds as the device data has to be transferred between the smartphone and the DVISION module.

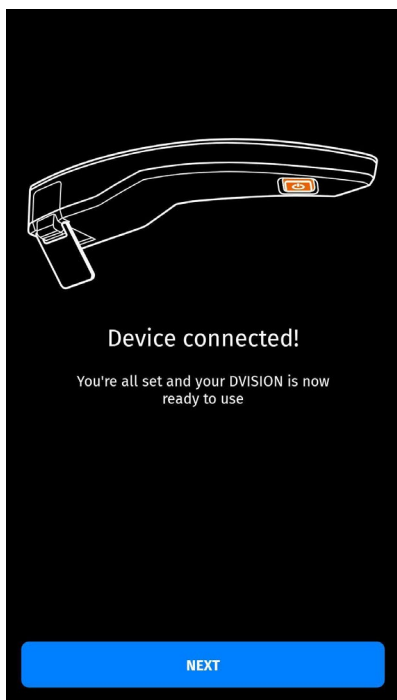

A message in the DVISION app lets you know once the devices have been paired successfully.

7. Tap “NEXT” to finalise pairing.

▶ You have successfully set up the DVISION app and paired your DVISION module with your smartphone.

The Bluetooth icon on the display is illuminated consistently. You can see the connection status in the DVISION app as well.

From now on, your DVISION module automatically connects to the DVISION app when you switch on the DVISION module.

Error message: Device not found

Sometimes, pairing fails.

1. Switch off the DVISION module.
2. Check the Bluetooth settings of your smartphone. If the DVISION module is listed under paired devices, delete the connection.
3. Repeat the pairing process. Make sure you perform the steps in the right order.
4. If you are unable to pair your DVISION module with your smartphone, contact the manufacturer to discuss what to do next (“Manufacturer’s contact details” on page 1).

4.2 Setting up and using the DVISION module

Charging



WARNING!

Do not leave the DVISION module unattended while charging. Only charge the battery in a dry place and at temperatures ranging from 0 °C to 45 °C (32 °F to 113 °F).



WARNING!

Charging the DVISION module in the helmet while riding can cause accidents and lead to serious injuries. Pulling on the charging cable can disconnect the DVISION module from the helmet adapter resulting in the DVISION module falling into the helmet during the ride. Never charge the DVISION module in the helmet during a ride.



NOTE!

Short charge cycles and complete discharges damage the battery and shorten its lifespan.

To preserve the lifespan of your battery, avoid short charge cycles. If possible, charge the DVISION module completely when the battery charge level reaches approx. 20%.



If you store your DVISION for an extended period of time, re-charge the battery approx. every 6 months.

Fully charge your DVISION module before you use it for the first time. Use the USB-C charging cable from the scope of delivery. As the power source, use a mains adapter with USB-A port or a suitable electronic device, such as a computer or a charged power bank.

1. Connect the USB-C charging cable to a mains adapter with a minimum output of 0.5 A.
 2. Connect the USB-C charging cable to the charging socket on the narrow end of the DVISION module.
- ▶ The DVISION module is being charged. The LED on the DVISION module lights up continuously.

Once charging is complete, the LED goes out. The full charge process takes approx. 4 hours, if the battery of the DVISION module was completely flat at the start.

Switching on and off

1. To switch on the DVISION module, push the operating button for approx. 1 second.
 The DVISION module is being activated. The LED flashes once.
2. To switch off the DVISION module, push the operating button for approx. 3 seconds.
 The DVISION module is being deactivated. The LED flashes twice.

Pairing mode

The DVISION module is constantly in pairing mode, but can only be connected to one smartphone at a time. After the initial coupling, the DVISION module automatically connects to the paired smartphone if it is within reach of the Bluetooth signal and Bluetooth has been activated. If you want to pair your DVISION module with another smartphone, ensure that there is no paired smartphone nearby, or switch off Bluetooth on the already paired smartphone.

4.3 Starting the navigation

Use the DVISION app to select your destination and route settings, and let the DVISION module guide you to your destination.

WARNING!





Inattentiveness in traffic can lead to accidents and serious injuries! Focus on your ride during the entire trip. Make all route settings and preparations before you start riding. If you want to make settings in the DVISION app during your ride, pull over when it's safe to do so and get off your motorbike.

Before you start your ride

1. Sufficiently charge your DVISION module and smartphone for the estimated duration of your ride.
2. Ensure that you have sufficient mobile data for the ride. An unstable internet connection can affect navigation.
If you are not sure or you are likely to spend significant time in areas with limited reception, you can download the map material for your route prior to starting your ride.
3. Clean the display. Streaks or dirt on the display can affect your vision during the ride.

4. Clean the LED. Dirt on the LED can prevent the integrated light sensor on the LED from correctly detecting the lighting conditions.
5. Make sure that the Bluetooth connection between the smartphone and the DVISION module is stable during the ride. Keep your smartphone in a pocket on your body. If heavy objects or your body come between your smartphone and the DVISION module, this can affect the connection.

Preparing the DVISION module and the DVISION app

1. Start the DVISION app.
2. Put your helmet on as usual.
3. Attach the DVISION module to the helmet adapter using the magnets and fold down the display at a 45° angle.
The display should be well visible in front of your right eye.
4. Switch on the DVISION module.
 A screen appears on the display. The DVISION module automatically connects to the DVISION app.
5. If necessary, adjust the angle of the display a little so that you can see the entire screen.
 You have prepared the DVISION module and the DVISION app for the ride.

Choose your destination

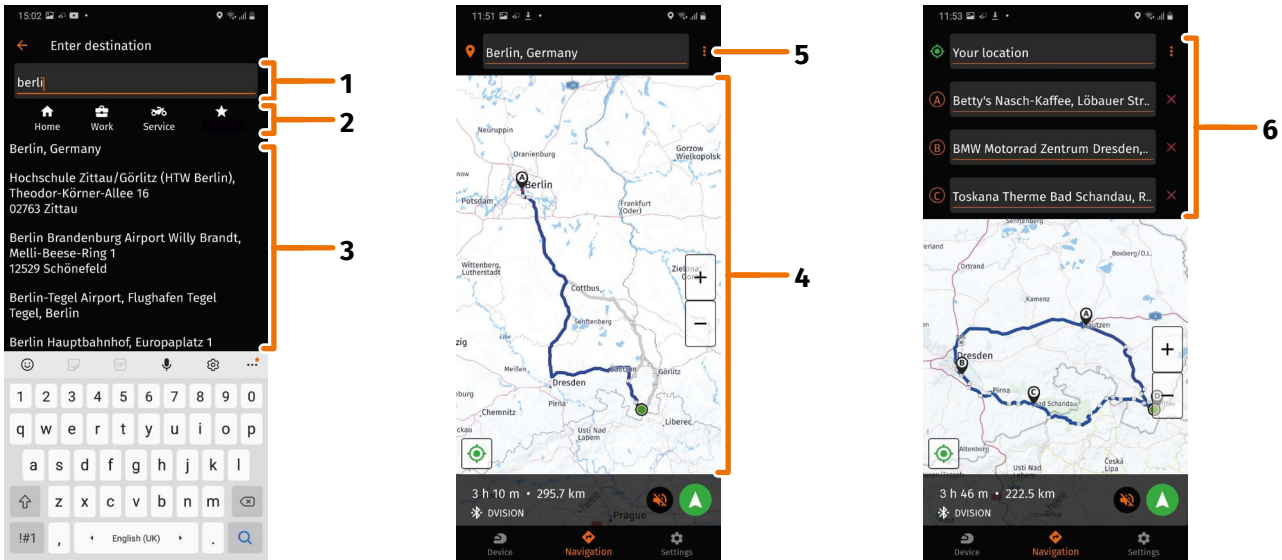

FIGURE 16 // Choosing a destination in the DVISION app

1. Choose your destination. You have four options for choosing your destination:
 - // Tap on the destination input field (FIGURE 16/1) via the navigation map and enter your destination. As the input progresses, matching destinations are displayed below the destination input field.
 - // Or you can search for your destination on the navigation map (FIGURE 16/4), tap on it and briefly keep the finger on the map. The DVISION app recognises the destination and adds it to the destination input field.
 - // Or you can select a personal destination from your favourites (FIGURE 16/2). To do so, tap on the destination input field and select a destination from your favourites. The DVISION app adds the destination to the destination input field.
 - // Or you can select a destination from your recent history (FIGURE 16/3). To do so, tap on the destination input field and select one of your recent destinations from the list below your favourites. The DVISION app adds the destination to the destination input field.

Adding stops

2. If you want, you can add up to ten stops to your route (FIGURE 16/6). To do so, tap on the three dots next to the destination input field (FIGURE 16/5) and choose “Add stop”.
 - ▶ The DVISION app adds an additional destination input field.
3. Choose the stop. The search via the navigation map is not available for this purpose.

4. If you want to change the order of the stops, tap one of the stops (FIGURE 16/6) and hold briefly. Then drag the destination into the desired position and release.
- ▶ You have specified your destination and the stops along the way for the route. The current route and your destinations are displayed on the navigation map.

Setting up your route

5. To do so, tap on the three dots next to the destination input field (FIGURE 16/5) and choose “Route options”.
 6. Make the settings of your choice in the list that appears now.
- ▶ The DVISION app will update the route, the expected travel time and the distance to the destination according to the settings. The DVISION app will notify you if the route options cause problems with the route guidance.

Starting the route guidance

7. Tap on “Start navigation”  to start the route guidance.
- ▶ The DVISION app starts the route guidance. Information about the route and turning directions are now shown on the display of the DVISION module.

INFO



If you cancel the route guidance via , the set route is deleted. You can interrupt the trip at any time, simply by stopping. You do not have to delete the route or pause route guidance. The DVISION app automatically re-calculates your estimated time of arrival and changes to the route.

4.4 Settings

You can use the Settings in the DVISION app to specify how your DVISION will guide you to your destination and what information will be displayed during your trip. You can also download the map material for offline navigation, update the firmware of your DVISION module and set the voices for voice announcements during navigation.

Configuring the display layout

You can adapt the information shown on the display to your personal requirements. Four basic layouts are available for that purpose:

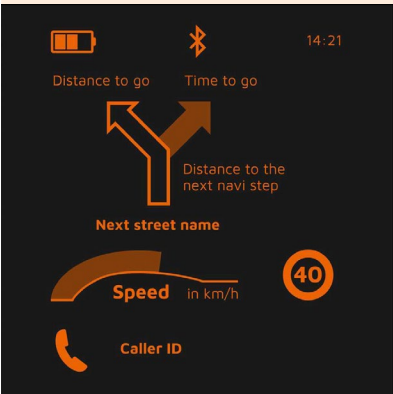

CITY

When riding in the city, your focus is on:

- // Navigation
- // Speed
- // Speed warning
- // Battery level of your DVISION module
- // Time
- // Status of the Bluetooth connection
- // Incoming calls

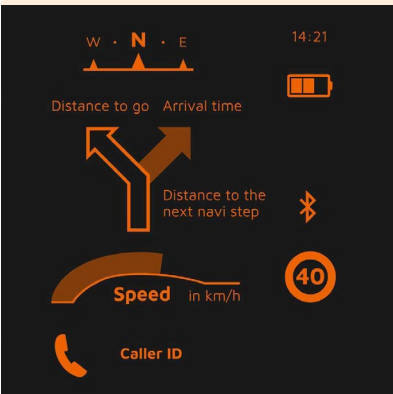

EXPLORER

Explore new places; you're well prepared with:

- // Navigation
- // Speed
- // Speed warning
- // Compass
- // Battery level of your smartphone and DVISION module
- // Time
- // Status of the Bluetooth connection
- // Incoming calls

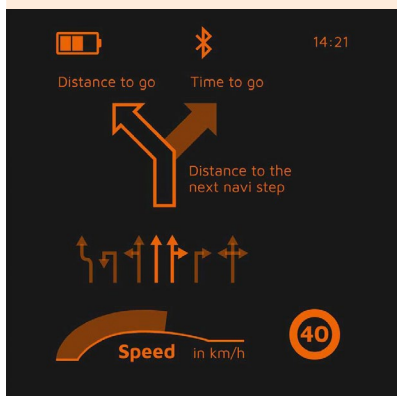

NAVIGATOR

On unknown routes, the display shows information on:

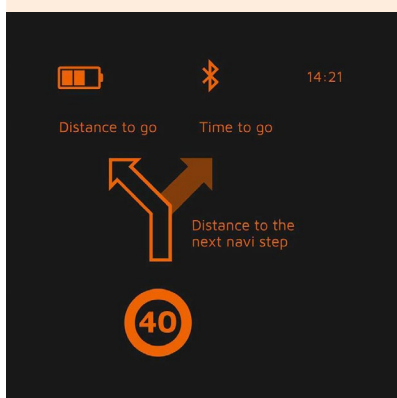

- // Advanced navigation with lane indicator
- // Speed
- // Speed warning
- // Battery level of your DVISION module
- // Time
- // Status of the Bluetooth connection



MINIMALIST

Go on a grand tour with the reduced display of:

- // Navigation
- // Speed warning
- // Battery level of your DVISION module
- // Time
- // Status of the Bluetooth connection

1. To change the layout, tap on "Device"  on the home screen of the DVISION app.
 2. Tap "Change layout".
 3. Choose your layout from the list. The layout that is currently selected is marked with a tick.
 4. You can customise the layout to suit your requirements. To do so, tap "Customise layout" in the respective layout.
 5. Show or hide any information, and choose your preferred display type for the time of arrival and your current location.
 6. Close the menu when you're done.
-  The settings are saved automatically. In the "Device" menu, the edited layout is shown as adapted.

Adjusting the brightness of the display



The automatic brightness adjustment is activated by default. The light sensor detects the ambient light and automatically adjusts the brightness of the display.

You can also deactivate the automatic brightness adjustment and set the brightness of the display yourself.



INFO

We recommend using the automatic brightness adjustment during the day. This prevents you from being blinded by the display if the lighting conditions change suddenly (for example, if you ride into a tunnel).

1. To change the display brightness, tap on “Device”  on the home screen of the DVISION app.
 2. Deactivate the automatic brightness adjustment.
 3. Move the integrated controller to select one of the three brightness levels.
-  Automatic brightness adjustment is deactivated and the brightness level you have selected is active.

Activating voice prompts

If, in addition to the DVISION module, you have a headset or headphones connected to your smartphone, you can activate voice prompts for navigation directions.



1. Start route planning.
2. To activate voice prompts, activate the option via the speaker icon.

Making settings



▶ To open the “Settings” menu, tap on “Settings”  on the home screen of the DVISION app.

In the “Settings” menu, you can make the following settings for the DVISION app:

Download maps

You can download map materials for different countries so that you can also access it offline.

Doing so enables you to get directions even when the internet connection is bad and lets you avoid roaming fees when you are abroad.



1. Choose the country for which you want to download the map material, and then tap on “Download”  next to it.
2. To delete the map material, choose the country and then tap on “Delete”  next to it.

Map updates

You can choose if updates for the downloaded map material are to be downloaded automatically or if you want to be notified first.

Voice settings

You can select and download your preferred language for navigation prompts.

1. Select your preferred language and then tap on “Download”  next to it.
2. To delete the language, select the language and then tap on “Delete”  next to it.

Speed warning

You can choose if you want to be notified if you exceed the speed limit.

Limit exceeded by km/h

The controller enables you to set the tolerance for the speed warning. For example, if you set the tolerance to 3 km/h, your DVISION will warn you if you exceed the specified speed by 3 km/h.

Day/night mode

You can specify if you want the navigation map display in the DVISION app to automatically change between day and night mode, or if you would like to choose your preferred mode yourself.

Alignment mode

In alignment mode, the frame is displayed as an orientation guide for mounting on the display of your DVISION.

DVISION connection status

The item indicates whether the DVISION app is currently connected to the DVISION module.

DVISION serial number

This item shows you the serial number of the connected DVISION module. Always have the serial number at hand when contacting customer service.

DVISION firmware version

This item shows you the firmware version of the connected DVISION module.

Firmware update

Here you can see if a new firmware version is available for your DVISION module, and update the firmware version.

1. To do so, open the “Firmware update” module and tap on “Update”.
 2. Keep your DVISION module switched on and connected to the DVISION app during the entire update process.
- ▶ Once the update is complete, the DVISION module is automatically restarted.

Version

This item shows you the version of the DVISION app that is currently installed.



INFO

Units of distance, the time format and the language settings in the DVISION app match the settings of your smartphone.

5 Troubleshooting

5.1 Reconnecting the DVISION module after pairing has failed

Sometimes, the pairing of your smartphone with the DVISION module fails.

1. Switch off the DVISION module.
2. Check the Bluetooth settings of your smartphone. If the DVISION module is listed under paired devices, delete the connection.
3. Repeat the pairing process (“Pairing the DVISION module with the DVISION app” on page 34). Make sure you perform the steps in the right order.
4. If you are unable to pair your DVISION module with your smartphone, contact the manufacturer to discuss what to do next (“Manufacturer’s contact details” on page 1).

5.2 Replacing the display

If the display is damaged and, for example, scratched or getting dull, you can replace it easily.

The required repair kit is available in the Tilsberk online shop:

tilsberk.com

Video instructions

You can find detailed video instructions for replacing the display on the Internet. To view the video, click on the link in your browser.

The video link will be available in April 2022.

Required components

You need the following components and tools to replace displays:

- // DVISION kit for replacing displays
- // Narrow flathead screwdriver

Replacing the display

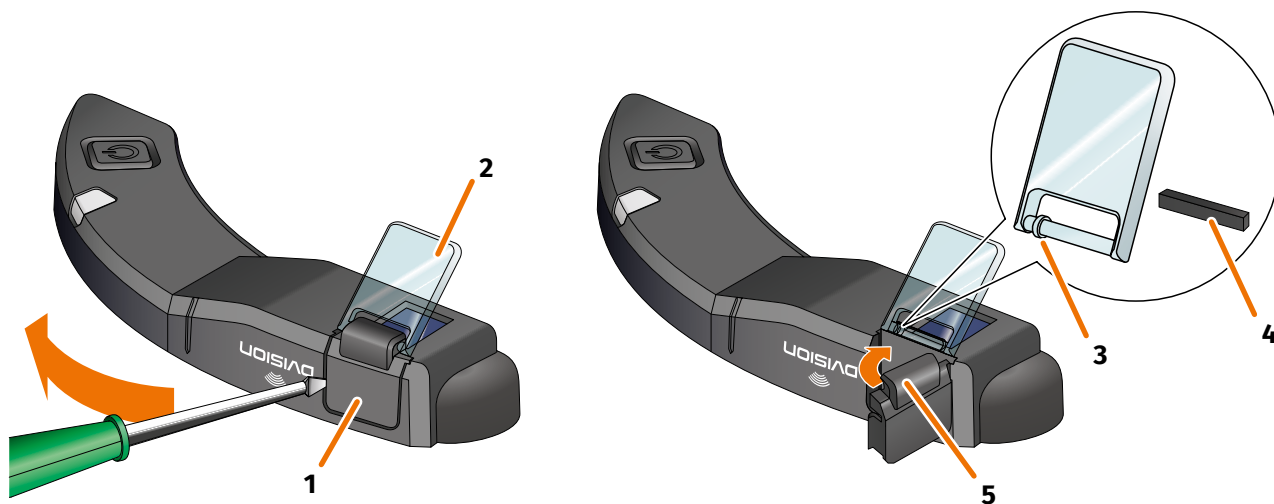

FIGURE 17 // Replacing the display

1. Place a screwdriver under the side of the display holder (FIGURE 17/1) and carefully lift up the display holder.
 2. Remove the display holder and the damaged display (FIGURE 17/2) from the DVISION module.
 3. Insert the new display into the DVISION module. Make sure that the alignment is correct. The small ring on the display (FIGURE 17/3) should point to the narrow side of the DVISION module.
 4. Insert the clamping wedge (FIGURE 17/4) into the support (FIGURE 17/5) on the display holder.
 5. Place one side of the display holder on the DVISION module, then push and swing it back into its position.
- ▶ You have replaced the display.

6 Technical data

Image generator:

Display type mono-coloured OLED display

Colour yellow-green

Wireless interface:

Bluetooth module v4.2

Transfer rate 1 MBps

Sending frequency 2400 – 2483.5 MHz

Maximum transmission power 8 dBm

DVISION module:

Dimensions 141 x 44 x 12 mm (collapsed display)

141 x 44 x 17 mm (extended display)

Weight approx. 44 g (DVISION module)

approx. 54 – 56 g (DVISION module with helmet adapter and Sugru or adhesive pads)

Control Navigation via the app for Android or iOS with speed recording and compass for offroad navigation

Sensors Light sensor for automatic adjustment of the display brightness to the ambient lighting

Battery type Lithium-ion polymer battery

Operating time approx. 12 h

Battery lifespan designed for 500 charge/discharge cycles

Interface USB-C charging socket

Protection class IP44

Operating and storage conditions:

Operating temperature (discharging)	0 °C to +50 °C
Operating temperature (charging)	0 °C to +45 °C
Storage temperature	0 °C to +50 °C
Storage humidity	45 % to 85 %

Sugru:

Consistency	kneadable adhesive that takes on a flexible, rubbery consistency when exposed to air
Handling time (room conditions, 25 °C, 50 % relative humidity)	30 min
Setting time (room conditions, 25 °C, 50 % relative humidity)	approx. 24 h with a layer thickness of 1.5 mm approx. 48 h with a layer thickness of 3 mm
UV resistance	Equivalent to 5 years of real weather exposure (visible UV and infrared radiation) according to Florida test ISO 4892
Temperature resistance	-40 °C to +180 °C
Water resistance	A 1 mm thick, set layer resists liquids (tap water) up to a pressure of 12 PSI in room conditions.

Simplified declaration of conformity

Europe

Digades GmbH hereby declares that the DVISION radio equipment type complies with Directive 2014/53/EU.

The complete text of the EU conformity declaration is available at the following web address:

dvision-hud.com/de/conformity

Great Britain

Digades GmbH hereby declares that the DVISION radio equipment type complies with applicable legal requirements.

The complete text of the EU conformity declaration is available at the following web address:

dvision-hud.com/de/conformity

Brands and licences

The Bluetooth® wordmark and logo are registered trademarks of Bluetooth SIG Inc.